

**Product Summary**

- VD2S2 (V) -20
- RDS(on) 120mΩ at VGS = 4.5 V (Typ)
- RDS(on) 160mΩ at VGS = 2.5 V (Typ)
- RDS(on) 220mΩ at VGS = 2.5 V (Typ)
- ID (A) ± 1.3
- Configuration Level-Shif

**Application**

- Battery Packs
- Battery-Powered Portable Equipment
- Cellular and Cordless Telephones

**Package and Pin Configuration**

**Circuit diagram**

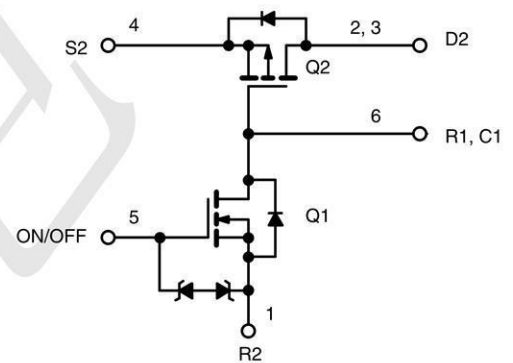
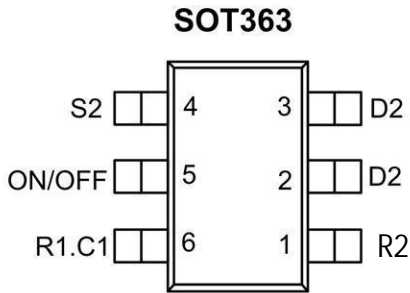

**Marking:**



VCQ= is Part Number ,Fixed  
VDG= is Part Number ,Fixed  
TP= TECH PUBLIC,Fixed

**Absolute Maximum Ratings (T<sub>A</sub>=25°C unless otherwise noted)**

PARAMETER	SYMBOL	Ratings	UNITS
Drain-source voltage (D2-S2)	V <sub>DS</sub>	-20	V
Input Voltage Range	V <sub>IN</sub>	20	V
On/Off Voltage Range	V <sub>ON</sub> /V <sub>OFF</sub>	8	V
Continuous Load Current	IL	1.3	A
Pulsed Load Current	ILM	3.9	A
Continuous intrinsic diode conduction	I <sub>S</sub>	0.4	A
Maximum power dissipation	P <sub>D</sub>	1.0	W
Operating Junction and Storage Temperature Range	T <sub>J</sub> ,T <sub>STG</sub>	-55~150	°C
ESD, MIL-STD-883D HBM (100pF/1.5kohm) (Von/off pin)	V <sub>ESD</sub>	2	kV
Typical Junction to Ambient <sup>(Note 2)</sup>	R <sub>θJA</sub>	250	°C/W

**Electrical Characteristics (  $T_A = 25^\circ\text{C}$  unless otherwise noted )**

PARAMETER	SYMBOL	TEST CONDITION	MIN.	TYP.	MAX.	UNITS
<b>Off Characteristics</b>						
Leakage Current	$I_{FL}$	$V_{IN}=8\text{ V}, V_{ON}/V_{OFF}=0\text{ V}$	-	-	1	$\mu\text{A}$
Diode Forward Voltage	$V_{SD}$	$I_S=-0.4\text{ A}$	0.4	0.6	1.1	V
<b>On Characteristics</b>						
Input voltage range	$V_{in}$			-	20	V
Drain to source breakdown voltage (Q2)	$V_{ds}$	$V_{GS} = 0\text{ V}, I_D = -250\ \mu\text{A}$	-20	-		V
Drain-Source On-State Resistance (Q2)	$R_{DS(on)}$	$V_{ON/OFF} = 1.5\text{ V}, V_{IN} = 4.5\text{ V}, I_D = 1.2\text{ A}$		120	150	m $\Omega$
		$V_{ON/OFF} = 1.5\text{ V}, V_{IN} = 2.5\text{ V}, I_D = 1\text{ A}$		160	210	
		$V_{ON/OFF} = 1.5\text{ V}, V_{IN} = 1.8\text{ V}, I_D = 0.7\text{ A}$		220	270	
Load Current	$I_L$	$V_{drop}=0.2\text{ V}, V_{in}=5\text{ V}, V_{on/off}=1.5\text{ V}$	1.0	-		A
		$V_{drop}=0.2\text{ V}, V_{in}=5\text{ V}, V_{on/off}=1.5\text{ V}$	1.0	-		

**Typical Application Circuit**

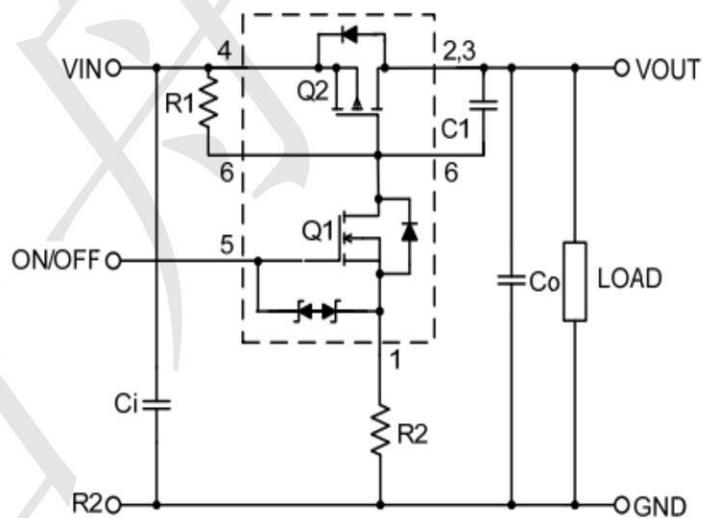

COMPONENTS		
R1	Pull-Up Resistor	Typical 10k $\Omega$ to 1M $\Omega$ *
R2	Optional Slew-Rate Control	Typical 0 to 100k $\Omega$
C1	Optional Slew-Rate Control	Typical 1000pF

**Typical Operating Characteristics**

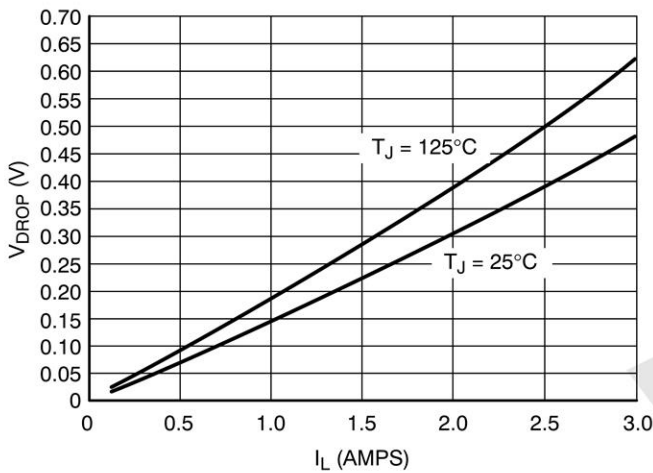

**Figure 2.  $V_{drop}$  vs.  $I_L$  @  $V_{in} = 2.5$  V**

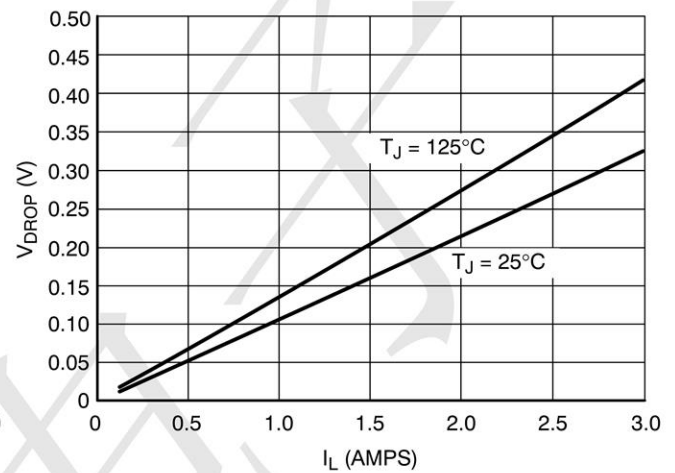

**Figure 3.  $V_{drop}$  vs.  $I_L$  @  $V_{in} = 4.5$  V**

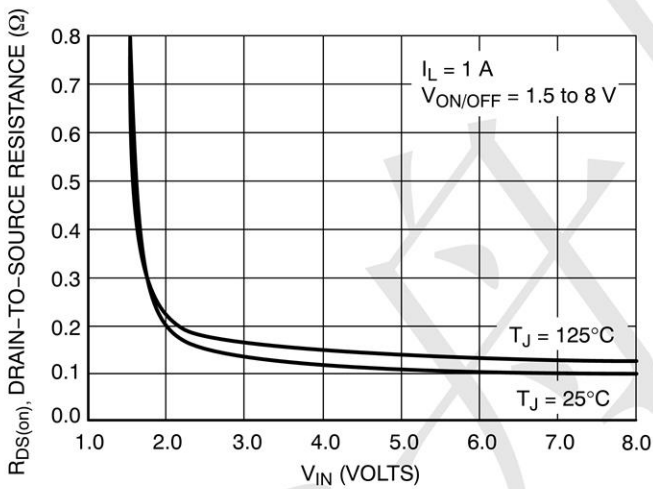

**Figure 4. On-Resistance vs. Input Voltage**

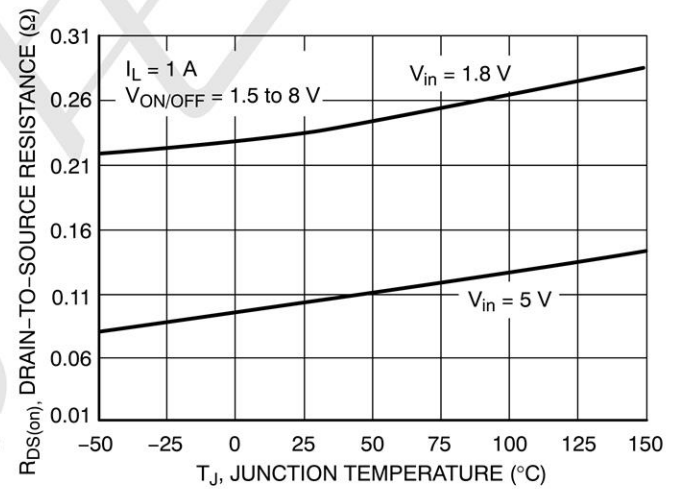

**Figure 5. On-Resistance Variation with Temperature**

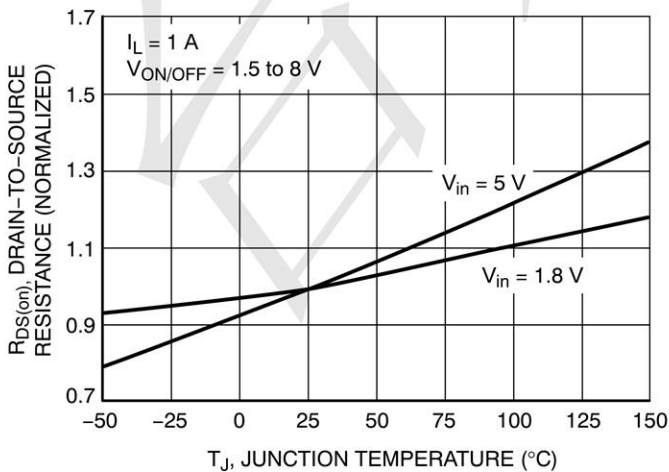

**Figure 6. Normalized On-Resistance Variation with Temperature**

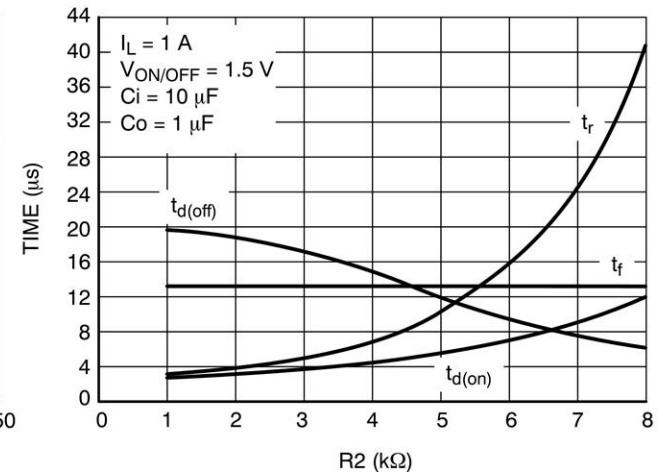

**Figure 7. Switching Variation  $R_2$  @  $V_{in} = 4.5$  V,  $R_1 = 20$  k $\Omega$**

TYPICAL PERFORMANCE CURVES ( $T_J = 25^\circ\text{C}$  unless otherwise noted)

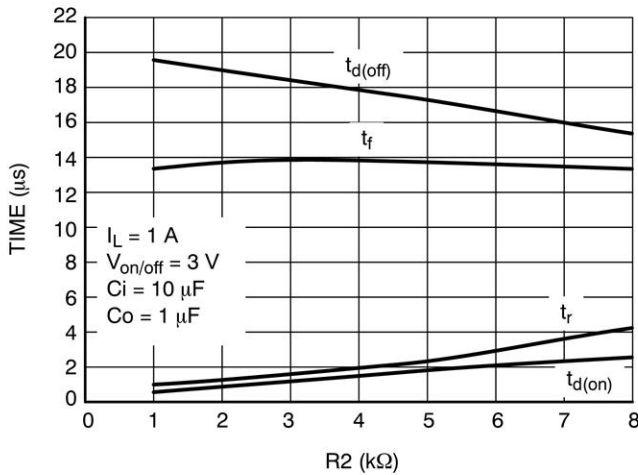

Figure 8. Switching Variation  
R2 @  $V_{in} = 4.5\text{ V}$ ,  $R_1 = 20\text{ k}\Omega$

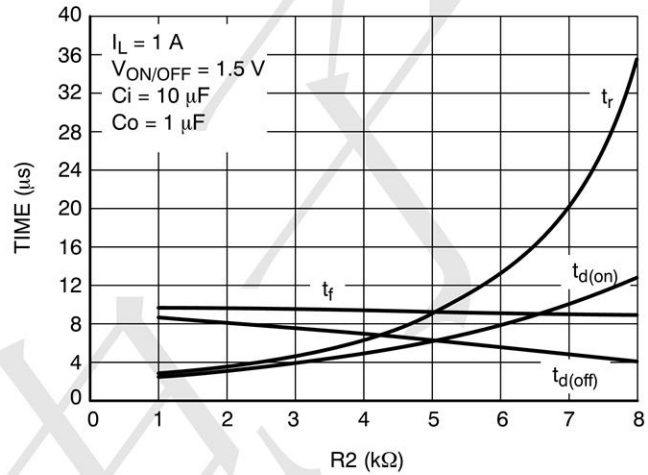

Figure 9. Switching Variation  
R2 @  $V_{in} = 2.5\text{ V}$ ,  $R_1 = 20\text{ k}\Omega$

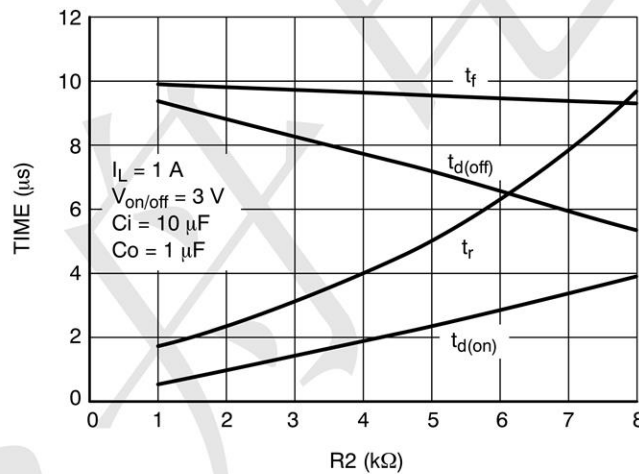

Figure 10. Switching Variation  
R2 @  $V_{in} = 2.5\text{ V}$ ,  $R_1 = 20\text{ k}\Omega$

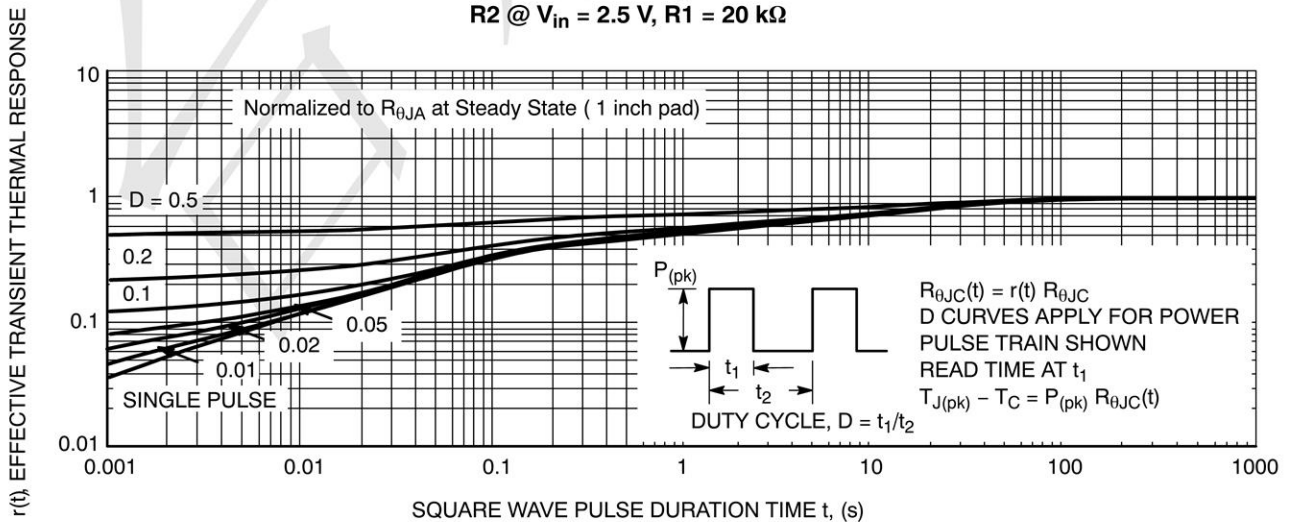
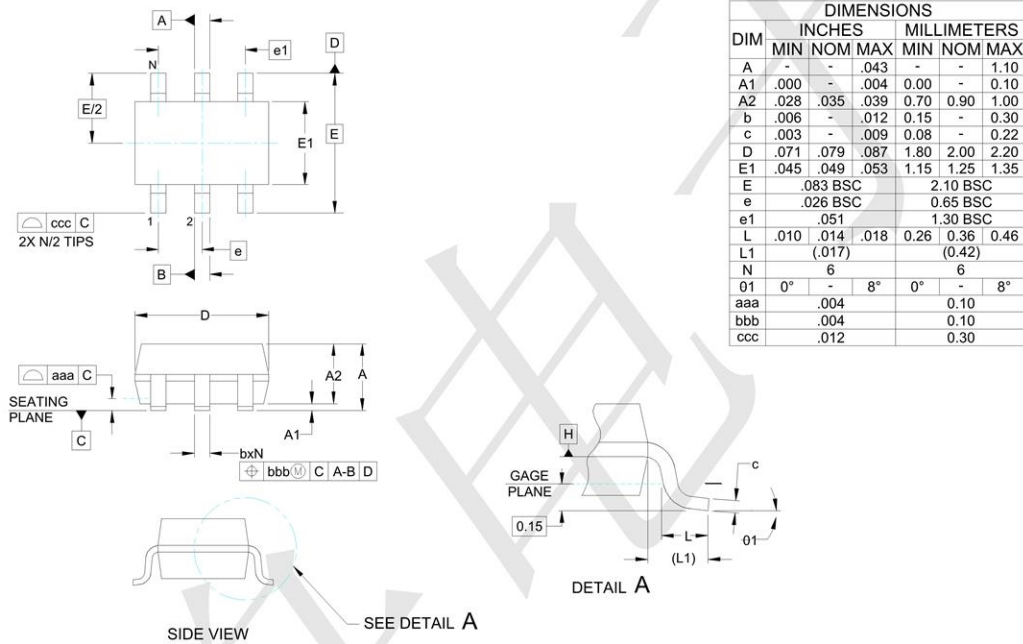

Figure 11. FET Thermal Response



**Outline Drawing - SOT-363**



**Land Pattern - SOT-363**

